

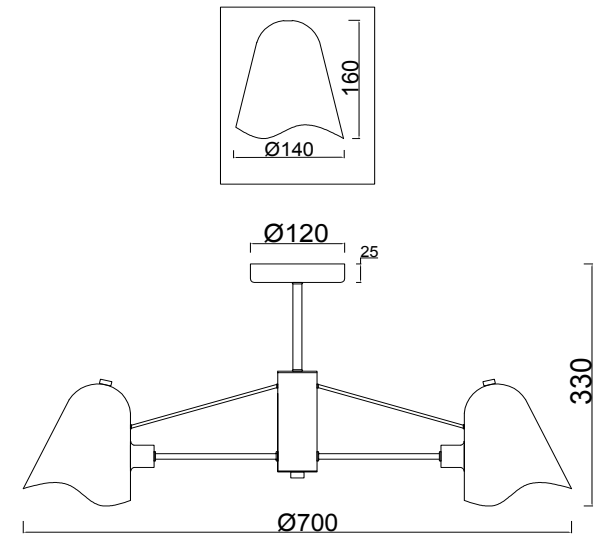

**FREYA**  
TRADITION OF QUALITY

# Instruction

FR5037PL-05S

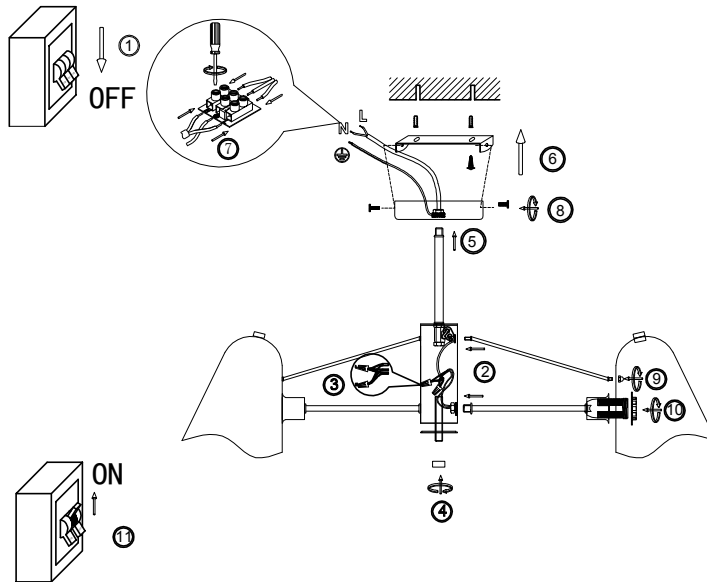

5 x E14 (40W)

Model: FR5037PL-05S  
Collection: Modern  
Series: Manon



Ceiling Lamps